



88126201



International Baccalaureate®
Baccalauréat International
Bachillerato Internacional

**DESIGN TECHNOLOGY
HIGHER LEVEL
PAPER 1**

Friday 9 November 2012 (afternoon)

1 hour

INSTRUCTIONS TO CANDIDATES

- Do not open this examination paper until instructed to do so.
- Answer all the questions.
- For each question, choose the answer you consider to be the best and indicate your choice on the answer sheet provided.
- The maximum mark for this examination paper is *[40 marks]*.

1. Which stage of the IB design cycle results in the design brief?
 - A. Identifying or clarifying a need
 - B. Generating the ideas and solutions
 - C. Developing the chosen solution
 - D. Testing and evaluating the chosen solution

2. What is true of morphological synthesis but **not** attribute listing?
 - A. It is an ideas generating technique
 - B. It uses a matrix approach to combining ideas
 - C. It supports brainstorming
 - D. It uses analogies

3. **Figure 1** shows an elevator (lift) shaft in a busy office building with a number of people waiting to board. The elevator receives instructions via display panels on the wall next to the elevator on each floor (floorcall) or from the panel within the elevator (panelcall). If the elevator is travelling up the elevator shaft it continues upwards until it has serviced all the calls or it reaches the top of the elevator shaft. It then changes direction and travels down servicing calls as it goes down until there are no more calls or it reaches the bottom of the elevator shaft when it again changes direction.

Figure 1: An elevator shaft in a busy office building

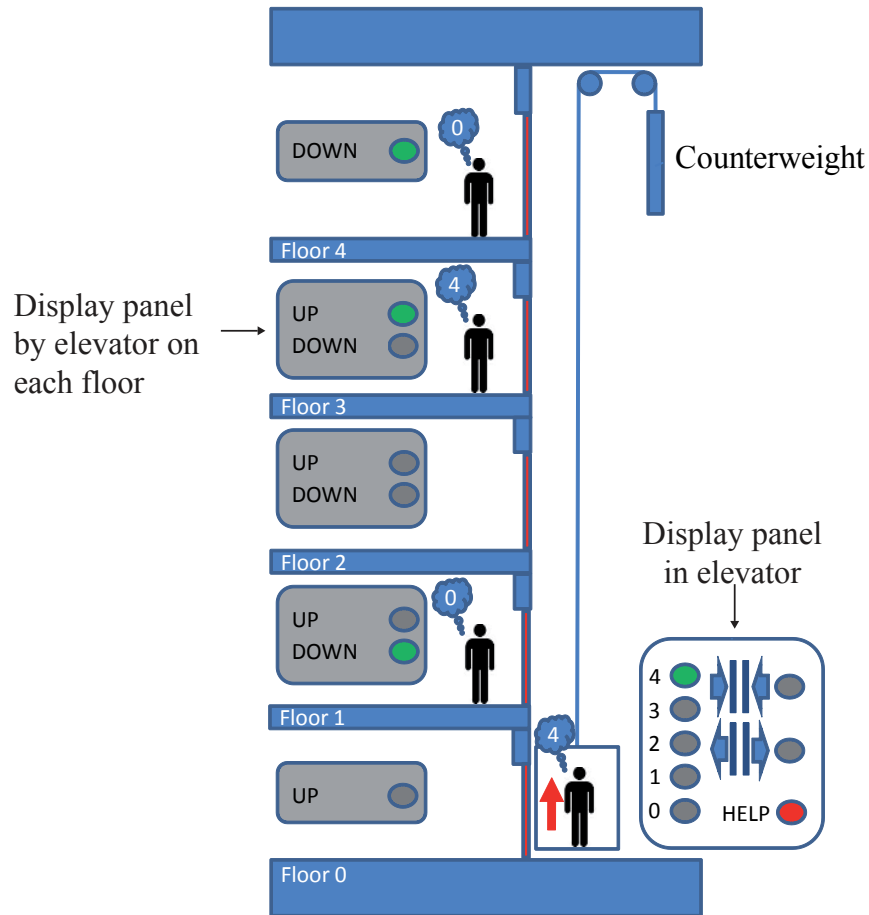

[© International Baccalaureate Organization, 2013]

Which method would be most appropriate for the instructions on the elevator operation?

	Algorithm	Flowchart
A.	No	No
B.	No	Yes
C.	Yes	No
D.	Yes	Yes

4. What is true of a flowchart but **not** an algorithm?
- A. It is used in problem-solving
 - B. It comprises a sequence of steps
 - C. It uses symbols to represent processes pictorially
 - D. It helps to communicate complex processes
5. What characterizes a pioneering strategy?
- I. It is a low risk strategy for a company
 - II. It offers a company the potential for a large profit
 - III. The company needs good research and development capability
- A. I and II
 - B. I and III
 - C. II and III
 - D. I, II and III
6. At which stages of the product life cycle is marketing of the product **most** likely to take place?
- I. Early stage
 - II. Mature stage
 - III. Late stage
- A. I and II
 - B. I and III
 - C. II and III
 - D. I, II and III

7. **Figure 2** shows an adjustable Panel Bin. **Figure 3** shows a non-adjustable bin.

Figure 2: The adjustable Panel Bin



Figure 3: Non-adjustable bin



[Source: www.yankodesign.com/2010/12/15/dustbin-of-many-sizes/]

At which stage of the product life cycle does the Panel Bin offer the **most** advantage over the ordinary waste bin?

- A. Production
- B. Distribution
- C. Utilization
- D. Disposal

8. Which objectives for the design of green products are addressed by replacing the use of chlorofluorocarbon (CFC) refrigerant with an alternative refrigerant?
- I. Increasing efficiency in the use of materials, energy and other resources
 - II. Minimizing damage or pollution from the chosen materials
 - III. Taking full account of the effects of the end disposal of the product
- A. I and II
 - B. I and III
 - C. II and III
 - D. I, II and III
9. Which design strategy would promote recycling?
- A. Minimizing handling in production
 - B. Minimizing the number of components
 - C. Using standard components
 - D. Minimizing the number of materials used for components
10. What is described as a mixture of two or more substances with one substance acting as the matrix or glue?
- A. Atom
 - B. Molecule
 - C. Alloy
 - D. Composite

11. What is defined as the ability of a material to be drawn or extruded into a wire or other extended shape?
- A. Plasticity
 - B. Elasticity
 - C. Malleability
 - D. Ductility

12. What characterizes natural timber?

	Along the grain	Across the grain
A.	Low tensile strength	Low tensile strength
B.	Low tensile strength	High tensile strength
C.	High tensile strength	Low tensile strength
D.	High tensile strength	High tensile strength

13. What characterizes the cooling of metals?

	Rapid cooling	Slow cooling
A.	Smaller grain size	Smaller grain size
B.	Smaller grain size	Larger grain size
C.	Larger grain size	Smaller grain size
D.	Larger grain size	Larger grain size

14. Why is urea-formaldehyde unsuitable for use as an adhesive in products which are designed to be disassembled by heating?
- A. It cannot be reshaped by heating
 - B. It is a thermoplastic
 - C. It has a rigid 3D structure
 - D. It comprises linear chain molecules
15. What is the advantage of Pyrex compared to ordinary glass?
- A. Reduced thermal expansivity
 - B. Reduced cost
 - C. Enhanced aesthetic properties
 - D. Enhanced transparency

16. Which manufacturing technique would have been used to produce the basket shown in **Figure 4**?

Figure 4: A basket



[Source: From: http://en.wikipedia.org/wiki/File:Handmade_basket_kudzu.jpg. Created by Matt Tommey.]

- A. Stitching
 - B. Weaving
 - C. Moulding
 - D. Using fasteners
17. Which aspect of assembly-line production has a major negative impact on the workforce?
- A. Interchangeable parts
 - B. Job standardization
 - C. Pre-processing of materials
 - D. Quality control

- 18.** What is a major concern for just-in-time (JIT) to manufacturers?
- A. Stock control
 - B. Steady demand for the product
 - C. A steady supply of components
 - D. Storage considerations
- 19.** In which design context would the 50th percentile be used?
- A. The height of a door
 - B. Mass produced clothing
 - C. A safety helmet
 - D. The height of a kitchen work surface
- 20.** What is an advantage of consumer associations for manufacturers?
- A. They are independent
 - B. They test manufacturer claims
 - C. They publish data for consumers
 - D. Good reviews can promote a product
- 21.** What is the major advantage of user trials?
- A. They are cost-effective
 - B. They don't require a prototype
 - C. They provide user feedback
 - D. They are time-consuming

22. The I-Green is a device designed by Fandi Meng which produces electrical energy to charge portable devices (see **Figure 5**).

Figure 5: The I-Green

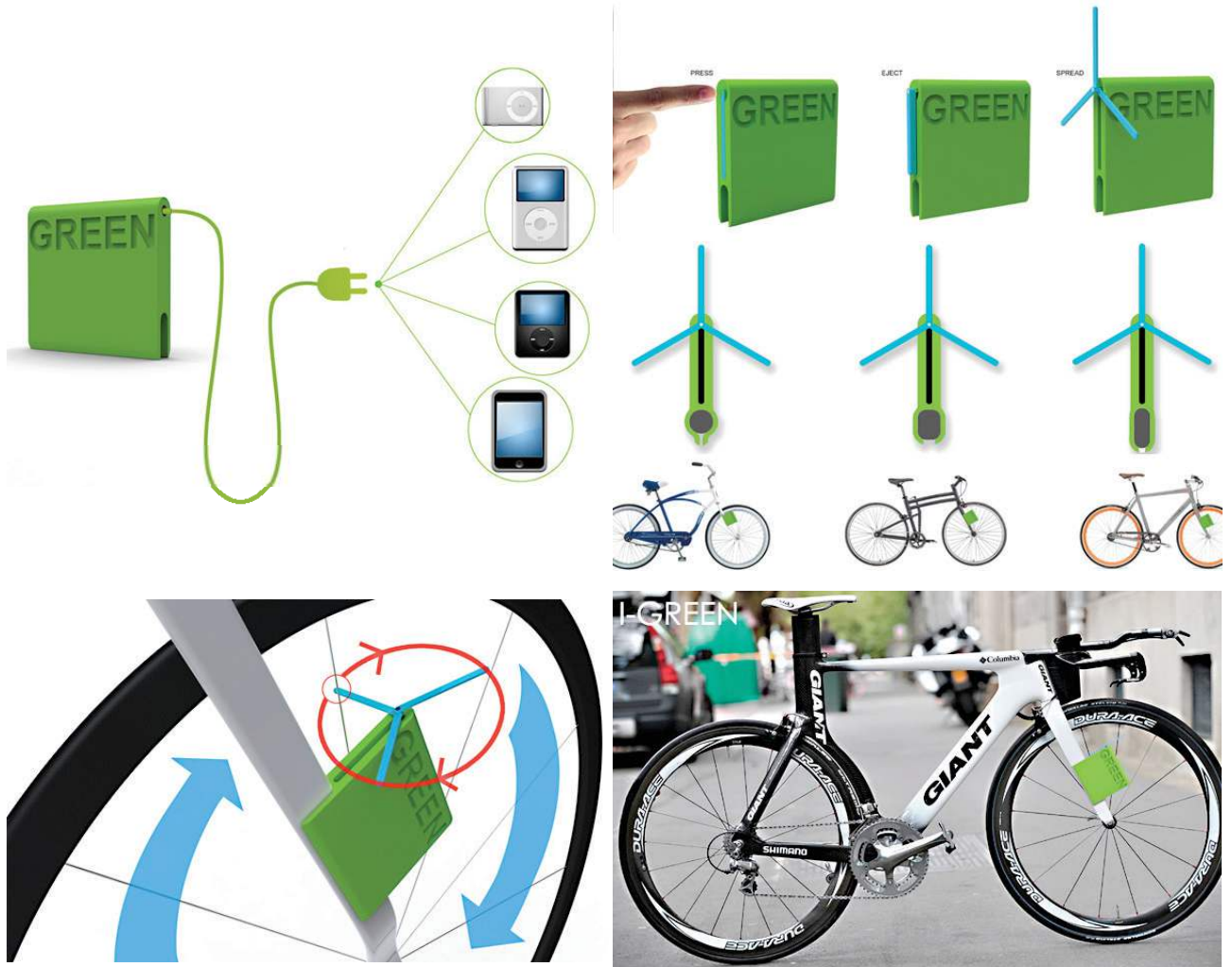

[Source: Fandi Meng. Used with permission.]

What type of energy is converted into electrical energy by the I-Green?

- A. Kinetic
- B. Potential
- C. Thermal
- D. Electromagnetic

23. The roof of Stadium Southland in New Zealand collapsed under an unusually heavy fall of very wet snow in September 2010 (see **Figure 6**). The stadium was built when the building regulations specified a snow load of 0.37 kiloPascals (kPa) and was designed to withstand 0.4 kPa. The snow that caused the collapse was in the range of 0.36 kPa and 0.45 kPa. The building code in New Zealand now stipulates a 0.63 kPa load.

Figure 6: Collapsed roof of Stadium Southland in New Zealand



[Source: From: ©AAP/Press Association Images]

What was the primary cause of the collapse of the roof?

- A. The design did not meet its specification
- B. The methods of construction of the building were inappropriate
- C. The building standards were incorrectly specified
- D. The building maintenance programme was ineffective

24. Why is an I-beam more cost-effective than a solid rectangular beam?
- A. Easier to produce
 - B. Greater resistance to torsion
 - C. Greater resistance to shear stress
 - D. Less material

25. Figure 7 shows a trolley carrying a computer.

Figure 7: A computer trolley.

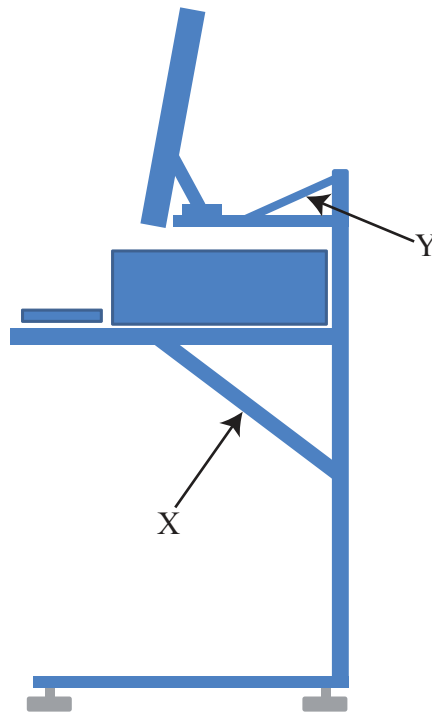

[© International Baccalaureate Organization, 2013]

What forces are acting on components X and Y?

	X	Y
A.	Tensile	Tensile
B.	Tensile	Compressive
C.	Compressive	Tensile
D.	Compressive	Compressive

26. Figure 8 (A–D) shows four pulley systems.

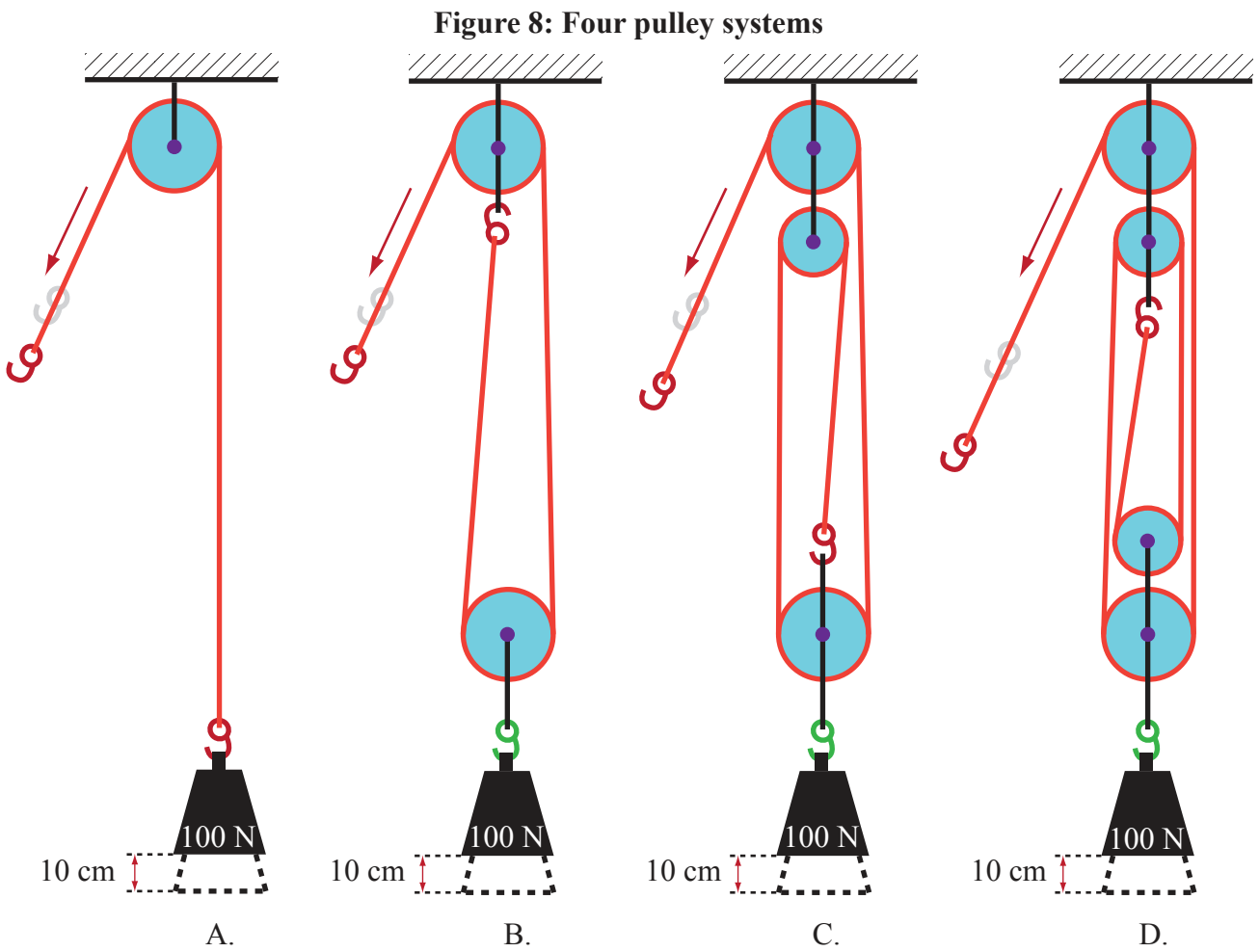

[© International Baccalaureate Organization, 2013]

Which pulley system has a mechanical advantage of 3?

27. What is an advantage of a ratchet and pawl system?

- A. It allows motion in only one direction
- B. It converts rotary motion into linear motion
- C. It converts rotary motion into reciprocating motion
- D. It increases the speed of rotation

28. An egg beater comprises a handle attached to a large gear that connects with two smaller gears, one on each beater (see **Figure 9**). Turning the handle causes the gears to rotate.

Figure 9: Egg beater



[Source: www.victorianpassage.com/2008/11/the_dawn_of_the_egg_beater.php]

What is changed by the gear mechanism in the egg beater shown in **Figure 9**?

- I. Axis of rotation
 - II. The speed of rotation
 - III. The type of movement
- A. I and II
 - B. I and III
 - C. II and III
 - D. I, II and III

29. What is flash in the context of injection moulding?
- A. The passage through which liquid material flows into a mould
 - B. It makes a product easier to remove from a mould
 - C. A short length of extruded pipe
 - D. The excess material on a moulded part
30. What is **not** an advantage of the friction welding process for metals?
- A. It is used for joining small parts
 - B. Little preparation of the material being welded is required
 - C. Different materials can be joined
 - D. It results in a strong joint
31. What is a disadvantage of high-pressure die casting?
- A. High accuracy
 - B. Thin walls
 - C. High rate of production
 - D. The size that can be cast

32. Rainwater falling on a roof can be collected and used for some domestic applications, *e.g.* flushing WCs (toilets) (see **Figure 10**).

Figure 10: Rainwater harvesting

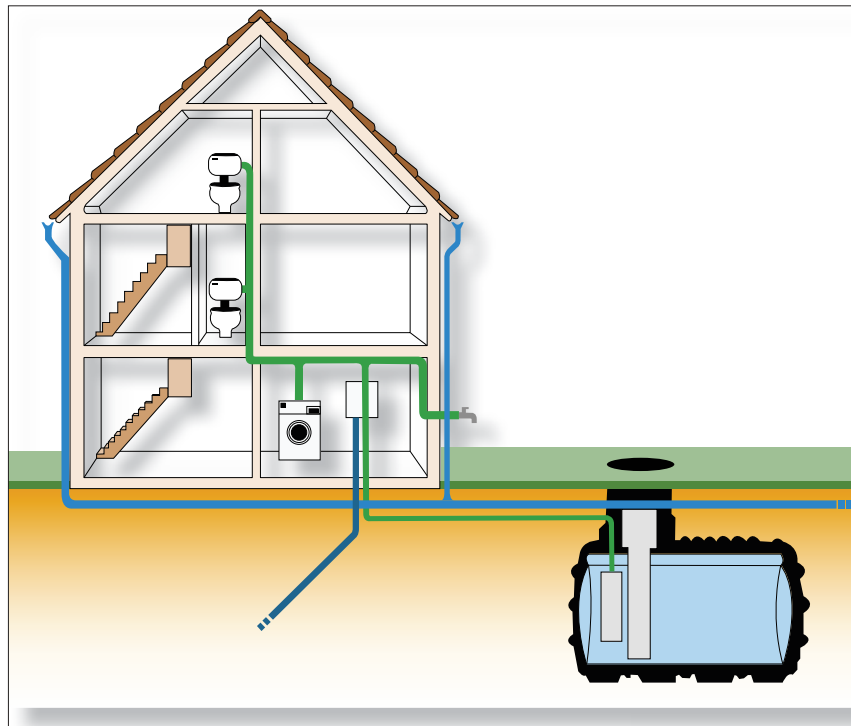

[Source: www.freerain.co.uk/domestic-rainwater-harvesting-systems.html. Used with permission.]

For which other purpose could harvested rainwater be used?

- A. Dish washing
- B. Personal washing
- C. Drinking water
- D. Watering gardens

33. **Table 1** shows the U values for four materials which could be used for the construction of the wall of a house as an alternative to brick which has a U value of 2.0 Wm^{-2} .

Table 1: U values for different materials	
Material	U value (Wm^{-2})
A.	A 3.0
B.	B 2.6
C.	C 2.2
D.	D 1.6

[© International Baccalaureate Organization, 2013]

Which material would be the best alternative to reduce heat loss through the wall?

34. What will contribute to reduced energy consumption in a building located at 35°S ?
- A. Elongate the east-west axis of the building
 - B. Elongate the north-south axis of the building
 - C. Locate less-used spaces on the north side of the building
 - D. Plant deciduous trees to the south of the building
35. How does daylighting contribute to reduced electricity consumption?
- I. Reduces usage of electrical lighting
 - II. Reduces waste heat produced by electrical lighting
 - III. Reduces cooling required to counter waste heat produced by electrical lighting
- A. I and II
 - B. I and III
 - C. II and III
 - D. I, II and III

Blank page

Questions 36–40 relate to the following case study. Please read the case study carefully and answer the questions.

Figure 11 and **Figure 12** show the front and back of a traffic management sign undergoing evaluation in a field trial. The sign integrates solar power and a wind turbine which charge a battery.

This type of sign has a number of advantages:

- they are bright and easy to read
- they are easy to install as they do not have to be connected to the national grid system
- they are low maintenance
- they are equipped with movement sensors so they light up if a vehicle approaches them too fast.

The signs are being constantly developed to produce a product family for a wide range of traffic management applications.

Figure 11: Front view of traffic management sign **Figure 12: Back view of traffic management sign**

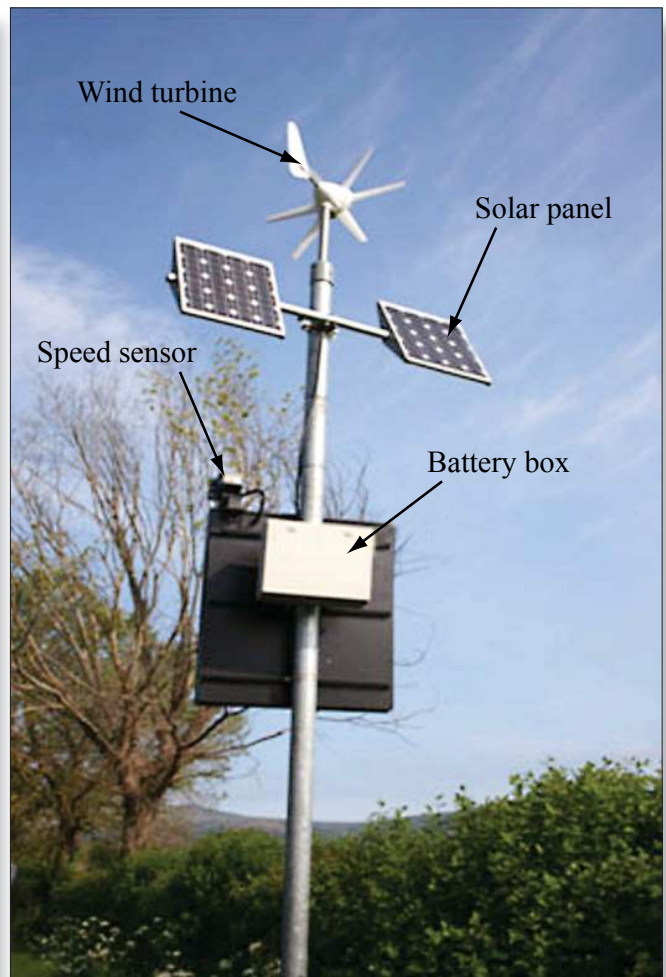
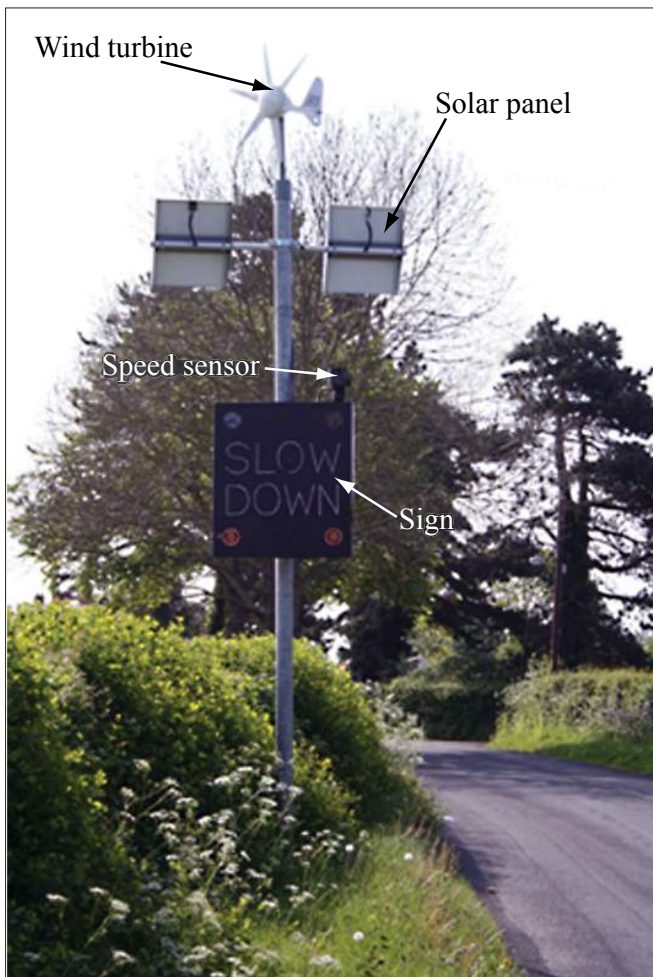

[© International Baccalaureate Organization, 2013]

36. What is the major benefit of adding a wind turbine to a solar-powered traffic sign?
- A. Continuity of supply
 - B. Cost-effectiveness
 - C. Ease of maintenance
 - D. Better lighting
37. Why is there a need for the traffic management sign to incorporate a battery?
- A. Lower running costs
 - B. To store electricity for use at night
 - C. To reduce the amount of electricity used
 - D. To generate electricity for the national grid
38. Which combination of “product” and “market” relates to the development of a product family of traffic management signs?

	Product	Market
A.	Existing	Existing
B.	New	Existing
C.	Existing	New
D.	New	New

39. What is **not** affected by applying “design for process” to the production of a product family of traffic signs?
- A. Fixed costs
 - B. Variable costs
 - C. Break-even point
 - D. Profitability
40. What is necessary in relation to undertaking a field trial to evaluate the traffic signs?
- I. Prototype
 - II. Expert
 - III. Time
- A. I and II
 - B. I and III
 - C. II and III
 - D. I, II and III
-